



CENTRAL HEATING AND COOLING

DUCTED HEAT PUMPS

WORLD LEADING

At Daikin, we're not just in the business of heat pumps. We're in the business of human comfort. Our passion for designing and engineering smart technologies ensures your comfort levels are maximised.

Daikin's recognised as an expert in air conditioning. As specialists, air conditioning is all we do. In fact, we're the only company in the world to make both heat pumps and refrigerants which enables us to deliver air conditioning solutions that are world leading in performance, quality and reliability.





CONTENTS

CENTRAL HEATING FOR YOUR HOME	4
CONTROL YOUR DAIKIN	6
PREMIUM INVERTER DUCTED	12
STANDARD INVERTER DUCTED	13
SLIM-LINE DUCTED	14
BULKHEAD SYSTEM	15
DAIKIN TECHNOLOGY	16
HOW TO BUY A DAIKIN PRODUCT	18
PRODUCT SPECIFICATIONS	20
FEATURES AND BENEFITS	25
FEATURES CHECKLIST	26



CENTRAL HEATING FOR YOUR ENTIRE HOME

DAIKIN DUCTED AIR

A Daikin Ducted Heat Pump provides discreet air conditioned comfort throughout your entire home. It can be installed in a new home or tailored to suit an existing one, with only the wall controller and discreet grilles visible inside.

A Daikin ducted heat pump consists of an indoor and outdoor unit with flexible ducting inside the roof. The indoor unit is concealed out of sight in your ceiling or under the floor, with flexible ducting distributing conditioned air through vents located throughout your home. An outdoor unit is positioned in a discreet location outside your home.

FLEXIBLE ZONING OPTIONS FOR YOUR HOME

Daikin ducted air conditioning gives you the flexibility to heat or cool every room in your home. Your home can be 'zoned' to maximise energy efficiency and comfort. For example, you may want the bedrooms in zone one, the living areas in zone two and so on. The position of discharge grilles can also be tailored to suit the shape of each room, for optimum air circulation.



DAIKIN DUCTED AIR CONDITIONING AT A GLANCE

Return air grille with filter to remove household dust

Indoor unit concealed in the ceiling or under the floor

Small diameter, concealed refrigerant pipes

Outdoor unit

Ducting distributes conditioned air throughout your home

Up to eight zones can be managed from a single controller

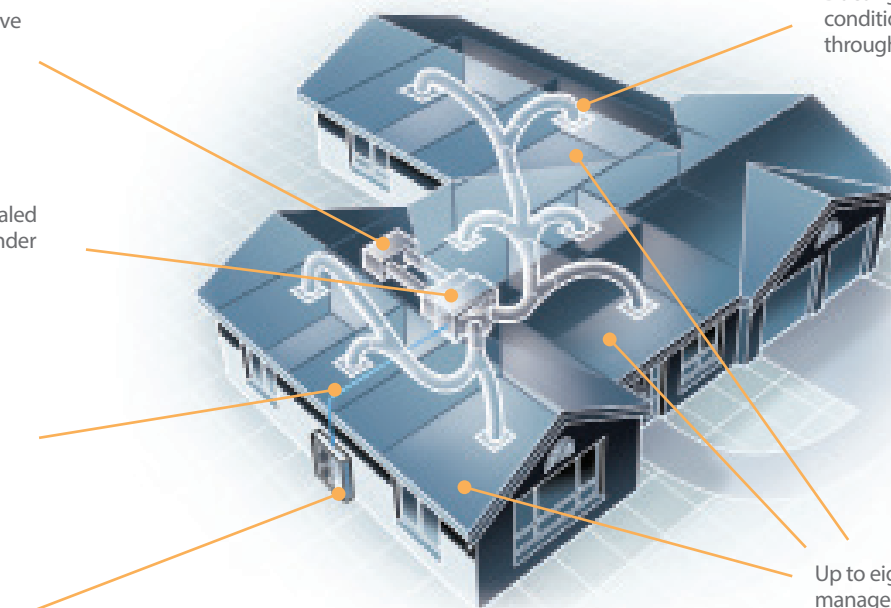

CONTROL YOUR DAIKIN

At Daikin, we have a range of controllers available to control your ducted air conditioning system to suit your lifestyle needs.



White

RAL 9003 (Glossy)
BRC1H519W



Silver

RAL 9006 (Metallic)
BRC1H519S



Black

RAL 9005 (Matt)
BRC1H519K



MADOKA

Madoka earned an IF design award and Reddot Product Design Award for its innovative design.

Available in three attractive colours, Madoka adds style and class to any interior. White offers a sleek, modern look. Silver gives an additional touch to stand out in any interior or application, while Black is an ideal match for darker, stylish interiors.

FEATURES

-  Compact Design - Measuring just 85 x 85mm, Madoka is extremely compact and will easily blend into your room's decor.
-  Intuitive Interface - easy to use touch button control.
-  Built-In Sensor and Status Indicator - Basic functions can be performed using the 3 on-screen touch buttons (Set point, Operation Mode etc).
-  Advanced Control - Using the Dakin Madoka app, advanced functions can be performed (scheduling, energy saving functions and servicing).



reddot award 2018
winner



MADOKA ASSISTANT APP WITH USER FRIENDLY INTERFACE



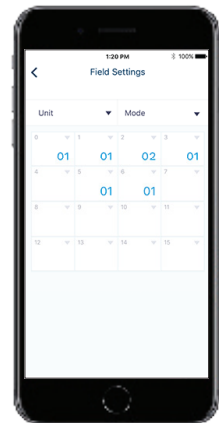
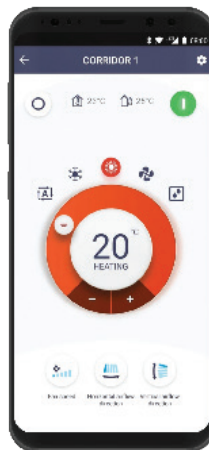



- Advanced settings and commissioning can be easily done via your smartphone.
- Connect with your smartphone via Bluetooth Low Energy communication.
- Visual interface helps you schedule, set point restriction and offers other settings for advanced users / technical managers.
- Easy and time-saving commissioning for installers.





NAV EASE CONTROLLER

FEATURES

-  Backlit Display - Clear large, easy to read text with an intuitive interface.
-  Weekly Schedule Time - Program on and off times to suit your lifestyle.
-  Home Leave Function - Can turn your air conditioner on automatically when room temperatures drop below 10°C.
-  Quick Cool / Heat Mode - Temporarily increases air conditioning power to rapidly reach your desired operating temperature, before automatically returning to normal operation.
-  Off Timer Feature - Automatically turns your air conditioner off after operating for a predefined time (30-180 mins).
-  Temperature Limit, to predefine a temperature range for cooling or heating cycles, helping you reduce your energy consumption.

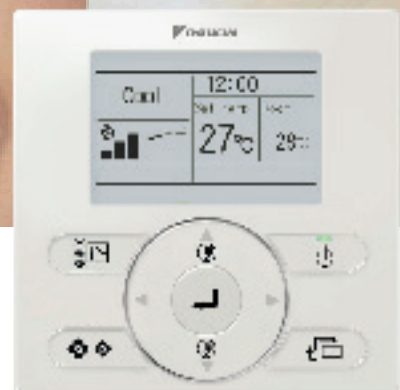

(Included with Premium Inverter Ducted and Standard Inverter Ducted models)







BRC1E63

Notes:

1. FDYQ, FDYQN and FBQ models only. FDXS models come standard with wireless remote controller ARC433A103
2. Zone Controller cannot be used in conjunction with any other controller besides the Daikin Sub Zone Controller option
3. For a full list of features of the controllers listed here, please speak to your dealer

ZONE CONTROLLER

FEATURES

-  Backlit Display - Clear large, easy to read text with an intuitive interface.
-  Multiple Zone Control - Control up to 8 zones, each zone can be tuned on or off depending on your requirements.
-  Countdown On/Off Timer - Quick and easy means to set up the operations of your unit.
-  7 Day Time Clock - Program on and off times, including when to open/close zones and the temperature sensor to use.
-  Automatic Mode Changeover - Allows the unit to automatically switch between heating and cooling for year round comfort.
-  Filter Cleaning Reminder - Automatic notification when filter cleaning may be required.



CONTROL
4^{TO} 8
DIFFERENT ZONES
PER CONTROLLER

(Optional with Premium Inverter Ducted and Standard Inverter Ducted models)







BRC2304	Up to four zones (230-240v)
BRC230Z8	Up to eight zones (230-240v)
BRC24Z4	Up to four zones (24v)
BRC24Z8	Up to eight zones (24v)
BRC5ZC	Second slave controller for double storey homes

ALSO AVAILABLE

BRC2A51	Simple L.C.D. wired remote controller
BRC4C62	Infra-red wireless remote control kit

WIRELESS REMOTE CONTROLLER

FEATURES

-  Intuitive Display - Clear large, easy to read text with a simple clean interface.
-  On/Off Timer - Program on and off times within the day to suit your needs.
-  Powerful Mode - Gives a boost in cooling or heating for 20 minutes beyond normal capacity.
-  Program Dry Function - Automatic intelligent airflow and temperature control to reduce room humidity.
-  Quiet Mode - Operation sound levels are reduced by 2-3dBA for quieter heating and cooling.
-  Econo Mode - Power consumption of the system is limited to prevent tripping your circuit breaker.



(Included with Bulkhead Ducted models)

ARC433A103



AIRZONE VAF ZONING SYSTEM



BLUEFACE

Main Controller

The Airzone VAF Zoning System is a variable airflow zoning system compatible with Daikin's range of residential and commercial range of ducted indoor units. It offers superior comfort by providing individual temperature control in each zone and improved energy savings via its intelligent fan speed control.

Each solution consists of Airzone touch controllers, 4-step linear dampers (12V) and a VAF control PCB with Daikin P1, P2 communication module*.



THINK

Zone Controllers



LITE

FEATURES



Touch Controllers - Featuring premium aesthetic design with intuitive touch screen interfaces for ease of use. Available in 3 models: Blueface, Think and Lite.



Q-Adapt Algorithm - The controller automatically selects the appropriate fan speed (L/M/H) depending on number of zones opened and the demand, resulting in reduced running costs.



Individual Temperature Control - The 4-step linear dampers precisely regulate airflow into each zone ensuring optimal temperatures for all occupants in the house hold at anytime.



Scalable Design - Up to 10 zones can be controlled via a single VAF system and coupled with a simple control architecture, this makes scalability and installation convenient.

*A BRC1E63 (Nav Ease) will also be required for backup and servicing

AIRBASE MOBILE APP

Daikin Airbase brings all your Ducted System's features* together with a simple to use app.



FEATURES



Countdown On/Off Timer - Quick and easy means to set up the operations of your unit.



Operation Mode Theming - Each operation is colour-coded for easy association.



Filter Cleaning Reminder - Automatic notification when filter cleaning may be required.



Zone On/Off- Turn on or off the zones in your home (requires Zone Controller).



Multiple Zone Control- Control up to 8 zones, each zone can be turned on or off depending on your requirements. (Requires Zone Controller).



Custom Zone Names- Customize the name of the zones through your home. (Zone Controller Required).

Download on the
App Store

GET IT ON
Google Play

*Some features only compatible with Daikin Zone Controller Each ducted system requires a BRP15B61 adaptor&mustbeconnectedonthesameWi-Finetwork



PREMIUM INVERTER DUCTED

Engineered to deliver remarkable energy performance, design flexibility and R22 retrofit capability, the Premium Inverter series is the ultimate ducted solution.

BEST FOR:

- Heating or cooling your entire home
- Small to large houses
- Retrofitting an old R22 ducted system



INDUSTRY LEADING ENERGY PERFORMANCE

Daikin's new Premium Inverter Series takes energy efficiency to the next level. Achieved with a redesigned cross-pass heat exchanger, DC fan motor and improved refrigerant control technology.



NIGHT QUIET MODE

Reduces the outdoor noise levels during sleeping hours and automatically resumes normal operations in the morning.



WIDE CAPACITY LIMIT

Allows continuous operations even on the hottest days of summer, or the coldest days of winter (max ambient temperature in Cooling 46°CDB and Heating -15°CWB).

* Applies to models - RZQS50AV1 to RZQS200AV1
Strict guidelines apply for R22 Retrofit Capability, please speak to your installer for further information.

CONTROLLERS:

NAV EASE
ZONE CONTROLLER
DAIKIN AIRBASE
AIRZONE
MADOKA

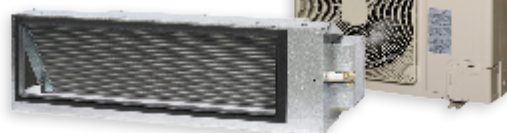

R22 RETROFIT CAPABILITY

Provides a cost effective and convenient upgrade from an existing R22 ducted system whilst retaining the field piping.*



DESIGN FLEXIBILITY

DC fan with a static pressure of 150Pa and up to 75m (100 Class) of available pipe run to suit your design layout.



AUSTRALIAN MADE

Indoor units are specifically designed and manufactured to Australian standards to withstand the harsher summer climate.

6.0kW
-TO-
28.6kW

RATED HEATING
CAPACITIES

14 SINGLE +
THREE

MODELS PHASE OPTIONS

STANDARD INVERTER DUCTED

Engineered to deliver a compact and efficient design, the new Standard Inverter series is ideal for installation into the tight roof space of any modern home.

BEST FOR:

- Heating or cooling your entire home
- Small to large houses
- Houses with limited roof space and outdoor space



IMPROVED ENERGY EFFICIENCY

Achieved through the use of a DC Fan motor on the indoor unit and a Cross-Pass Heat Exchanger on the outdoor unit.



NIGHT QUIET MODE

Reduces the outdoor noise levels during sleeping hours and automatically resumes normal operations in the morning.



15 FAN SETTINGS

15 different fan speed settings to suit your ductwork configuration.



COMPACT SIZE

140 and 160 Class is now housed in a compact indoor casing for easier installation.



AUSTRALIAN MADE

Indoor units are specifically designed and manufactured to Australian standards to withstand the harsher summer climate.

CONTROLLERS:

NAV EASE
ZONE CONTROLLER
DAIKIN AIRBASE
AIRZONE
MADOKA



7.5kW
-TO-
26.8kW

RATED HEATING
CAPACITIES

8

MODELS

SINGLE +
THREE

PHASE OPTIONS

SLIMLINE DUCTED

Designed specifically to suit installations where ceiling space is at a premium, our Slim-Line Ducted series has unparalleled flexibility and freedom of design.

Ideal for narrow ceiling spaces or under the floor, this ducted system meets the challenges of modern commercial and medium density apartment development.

BEST FOR:

- Heating or cooling multiple rooms
- Narrow ceiling spaces
- Bedroom air conditioning



SLIM-LINE INDOOR

Industry leading low profile design of 245mm height ensures clearance in most narrow roof spaces.



AUTOMATIC AIRFLOW ADJUSTMENT

Allows the fan speed to adjust automatically to suit your duct design for optimum airflow distribution.



DESIGN FLEXIBILITY

DC fan with a static pressure of 150Pa and up to 75m (100 Class) of available pipe run to suit your design layout.

CONTROLLERS:

NAV EASE
ZONE CONTROLLER
DAIKIN AIRBASE
AIRZONE
MADOKA



FLEXIBLE RETURN AIR

Option of a rear or bottom suction return allows for greater installation flexibility.



R22 RETROFIT CAPABILITY

Provides a cost effective and convenient upgrade from an existing R22 ducted system whilst retaining the field piping.*



BUILT-IN CONDENSATE PUMP

DC Condensate pump is equipped as standard with a 850mm lift.

6.0kW
-TO-
11.2kW

RATED HEATING CAPACITIES

5

MODELS

SINGLE +
THREE

PHASE OPTIONS

BULKHEAD SYSTEM

The Bulkhead range is the ideal choice for air conditioning areas where a discreet installation is preferred.

The indoor unit fits flush into the ceiling with only the suction air and discharge grilles visible inside your home, leaving maximum floor and wall space for furniture, decoration and fittings. The Bulkhead range is truly discreet with whisper quiet operations to ensure limited impact to internal room aesthetics and acoustics.

BEST FOR:

- Heating or cooling one area of your home
- Drop ceilings & shallow ceilings
- Bedroom air conditioning



ULTRA COMPACT

Compact form factor - measuring at 200mm (H) and 620mm (D), makes it suitable for a variety of applications.



QUIET OPERATION

Noise levels are truly discrete and whisper quiet at 35dBA (25 Class Model).



AUTO FAN SPEED

An optimal fan speed is automatically selected to suit the set temperature for a more efficient operation.



FLEXIBLE RETURN AIR

Option of a rear or bottom suction return allows for greater installation flexibility.



NIGHT SET MODE

Temperatures are gently adjusted to prevent excessive cooling/heating for a more pleasant night's sleep.



STANDBY POWER FUNCTION

Automatically reduces energy consumption when the system is not in use.

CONTROLLER:

WIRELESS
REMOTE
CONTROLLER



3.2kW
-TO-
7.0kW

RATED HEATING
CAPACITIES

4

MODELS

SINGLE

PHASE OPTIONS

DAIKIN TECHNOLOGY

INDOOR UNIT

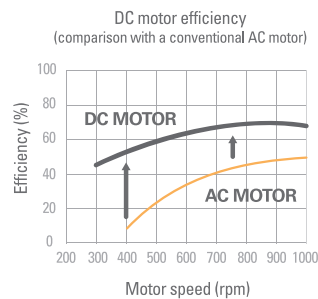
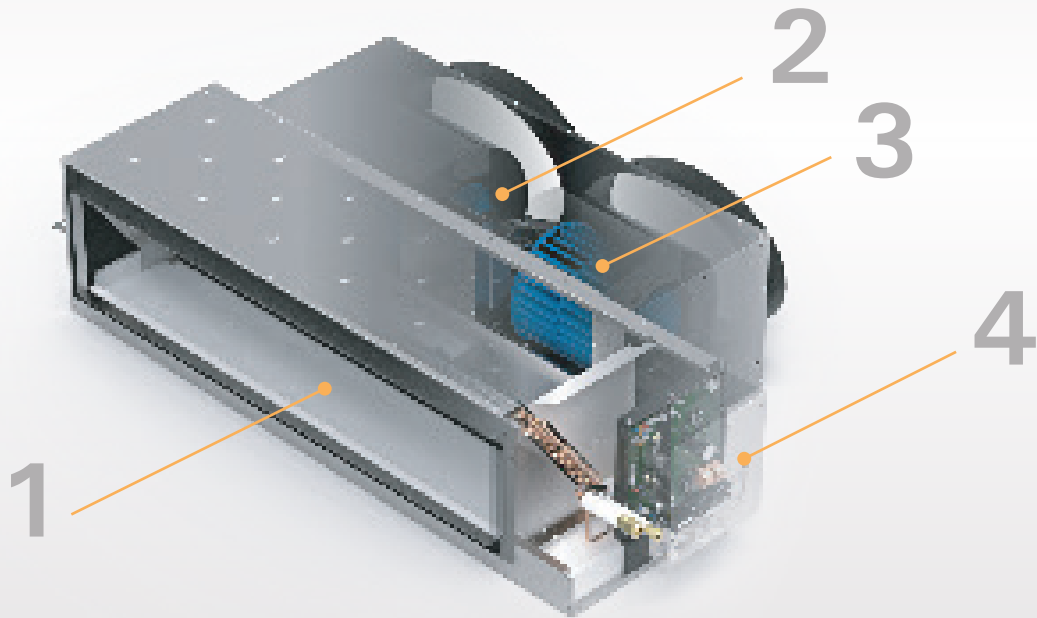

1

INDOOR HEAT EXCHANGER

Our new indoor heat exchangers have been designed to deliver maximum capacity output in a compact casing size. Through the use of cutting edge technologies, our indoor heat exchangers utilise Ø5mm copper pipes to ensure heat is removed from your home efficiently.

2

DC FAN MOTOR

Daikin indoor units are equipped with a high efficiency DC fan motor. By utilising high power permanent magnets instead of the induced magnetism of conventional AC motors, Daikin's DC motor can deliver significantly higher motor efficiency.

3

SIROCCO FAN

Daikin's ducted units are fitted with light weight single injection moulded Sirocco Fans. These fans feature an aerodynamic fan blade design which reduces turbulence for a more efficient and quieter airflow delivery.

4

PMV CONTROL

In automatic mode, Predicted Mean Vote control measures indoor and outdoor temperatures to calculate the ideal room temperature. As conditions change throughout the day, PMV Control gently adjusts your room temperature, maintaining an optimum balance between efficiency and comfort.

For over 90 years, Daikin has invested heavily in Research and Development to deliver more effective climate control for you and your family. Daikin technologies help make Daikin heat pumps energy efficient, powerful, reliable and easy to use.

OUTDOOR UNIT

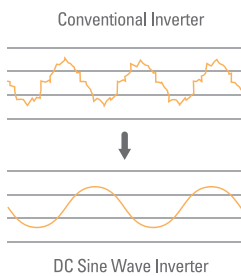
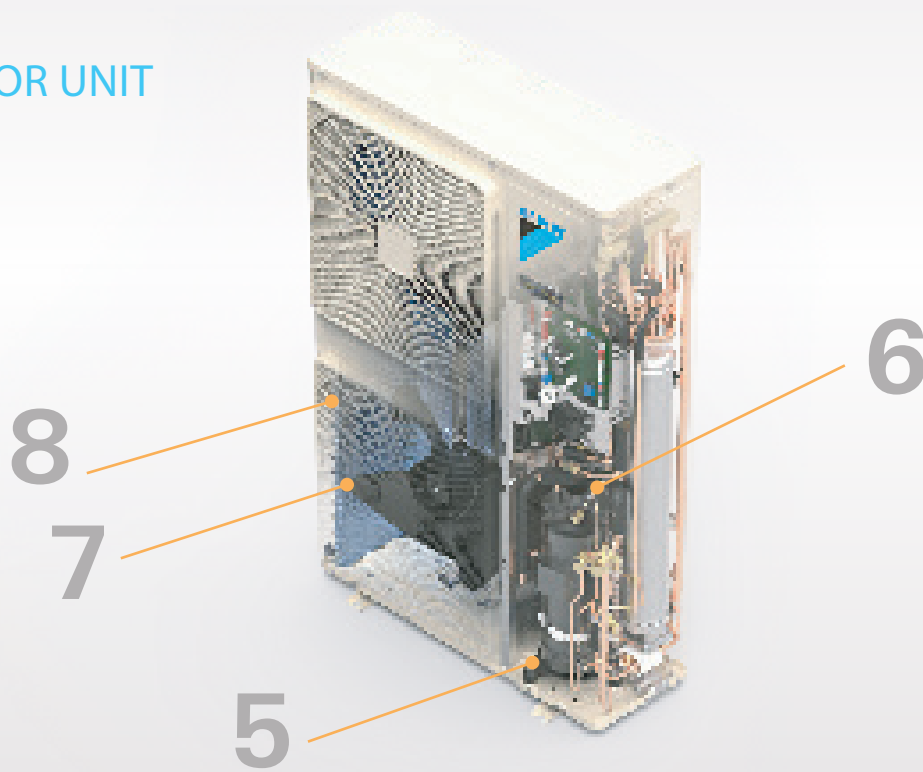

5

INVERTER COMPRESSOR

Daikin's swing and scroll DC sine wave inverter compressors are quieter and more efficient than conventional compressors, thanks to their high pressure dome construction and the usage of high pressure lubrication oil.

6

RELUCTANCE DC MOTOR

Daikin's Reluctance DC motor utilises the magnetic torque of neodymium magnets in conjunction with reluctance torque, resulting in more energy efficient operation. These neodymium magnets are 10 times stronger than conventional ferrite magnets.

7

SAW EDGE FAN BLADE

The addition of a saw tooth edge at the rear of the blade smooths air flow over the blade surface, reducing turbulence which in turn results in a quieter, more efficient means of delivering comfort to your home.

8

CROSS-PASS HEAT EXCHANGER

Daikin's Cross-Pass Heat Exchanger crosses refrigerant flows from two directions, reducing temperature hot-spots for more efficient operation and enhanced performance compared to single pass heat exchangers.

HOW TO BUY A DAIKIN PRODUCT

Buying a new Daikin is as simple as contacting one of our trusted **Daikin Specialists**. Our Specialists have years of local experience and expertise in the air conditioning industry, ensuring that you get top quality advice and support for your needs.

IN-HOME QUOTATION

Daikin Specialists provide custom designed solutions for your home through an in-home quotation. Specialists will not only supply and install the best possible air conditioning solution but will also provide ongoing maintenance to ensure peak efficient performance over the life of the system.

To take the stress out of air conditioning your home, speak to a Daikin Specialist. With over 50 Specialist Dealers across New Zealand, we are ready to help you fit the right air conditioning solution for your home.



5 year
WARRANTY

DAIKIN SPLIT SYSTEMS COME WITH A 5 YEAR PARTS AND LABOUR WARRANTY TO GIVE YOU PEACE OF MIND WHEN PURCHASING A NEW DAIKIN.

Subject to Conditions

To find your nearest Daikin Specialist, visit: www.daikin.co.nz or call 0800 20 90 10



PRODUCT SPECIFICATION

Premium Inverter - Single Phase



RZQS50A
RZQS60A



RZQS71A



RZQS100A
RZQS125A
RZQS140A
RZQS160A



FDYQ50D
FDYQ60D



FDYQ71LB



FDYQ100LB



FDYQ125LB

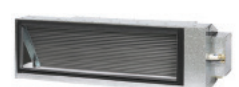

FDYQ140LC
FDYQ160LB

INDOOR UNIT		FDYQ50DV1	FDYQ60DV1	FDYQ71LBV1	FDYQ100LBV1	FDYQ125LBV1	FDYQ140LCV1	FDYQ160LBV1
OUTDOOR UNIT		RZQS50AV1	RZQS60AV1	RZQS71AV1	RZQS100AV1	RZQS125AV1	RZQS140AV1	RZQS160AV1
Rated Capacity	Cool (kW)	5.1	6.0	7.1	10.0	12.5	14.0	16.0
	Heat (kW)	6.0	7.0	7.5	12.5	15.0	16.5	18.0
Capacity Range	Cool (kW)	3.2-5.6	3.2-6.0	3.2-8.0	5.0-11.2	5.7-14.0	6.2-15.5	7.3-16.3
	Heat (kW)	3.5-7.0	3.5-8.0	3.5-9.0	5.1-12.8	6.0-16.2	6.2-18.0	7.3-18.2
Power Input (Rated)	Cool (kW)	1.5	1.71	2.05	2.69	3.68	4.13	4.92
	Heat (kW)	1.62	2.09	1.89	3.02	3.79	4.29	4.72
E.E.R./C.O.P	Cool/Heat	3.40/3.70	3.51/3.35	3.46/3.96	3.72/4.14	3.40/3.96	3.39/3.85	3.25/3.81
Airflow Rate (Rated)	l/s	370	400	566	800	840	1000	1120
Indoor Sound Level (H) @ 1.5m	dB(A)	44.4	45.2	41	44	45.5	46	48
Piping Length	(m)	50			75			
Indoor Fan Speeds		H/M/L						
Dimensions (HxWxD)	Indoor (mm)	300x1015x851		300x1090x863	360x1157x899	360x1400x899	430x1400x943	
	Outdoor (mm)	770x900x320		990x940x320	1430x940x320			
Weight	Indoor (kg)	35	35	40	44	59	62	62
	Outdoor (kg)	64	64	75	108	108	108	117
Power Supply	V/Hz	1 Phase, 220-240V, 50Hz						
Compressor Type		Hermetically Sealed Swing Type			Hermetically Sealed Scroll Type			
Refrigerant		R410A						
Pipe Sizes	Liquid (mm)	6.4 (Flared)			9.5 (Flared)			
	Gas (mm)	12.7 (Flared)			15.9 (Flared)			
	Drain (mm)	ID 25 / OD 32						
Supply Air Opening	mm (HxW, Flange)	202x762		185x852	245x852	245x1152	315x1152	
Return Air Opening	mm (Oval)	1x400 (Oval)			2x400 (Oval)			
Outdoor Operating Range	Cool (°CDB)	-5 to 46						
	Heat (°CWB)	-15 to 16						
EPA Sound Power Level	dB(A)	66	66	69	69	-	-	-
Outdoor Sound Level (H) @ 1m	PressuredBA(C/H)	48/50		50/52	53/55	54/56		57/59

Notes:

- i. The Rated Capacity, Power Input and Running Current are measured in accordance with AS/NZS 3823.1.2
Cooling: Indoor temp: 27°CDB/19°CWB, Outdoor temp: 35°CDB/24°CWB
Heating: Indoor temp: 20°CDB/15°CWB, Outdoor temp: 7°CDB/6°CWB
- ii. Indoor and outdoor sound levels are determined in an anechoic chamber and may differ on the unit is installed due to ambient conditions

PRODUCT SPECIFICATION

Premium Inverter - Three Phase



RZQS100A
RZQS125A
RZQS140A
RZQS160A



RZYQ7T
RZYQ8T
RZYQ10T



FDYQ100LB



FDYQ125LB



FDYQ140LC
FDYQ160LB



FDYQ180LC
FDYQ200LC
FDYQ250LC

INDOOR UNIT		FDYQ100LBV1	FDYQ125LBV1	FDYQ140LCV1	FDYQ160LBV1	FDYQ180LCV1	FDYQ200LCV1	FDYQ250LCV1	
OUTDOOR UNIT		RZQS100AY1	RZQS125AY1	RZQS140AY1	RZQS160AY1	RZYQ7TY1	RZYQ8TY1	RZYQ10TY1	
Rated Capacity	Cool (kW)	10.0	12.5	14.0	16.0	18.0	20.0	24.0	
	Heat (kW)	12.5	15.0	16.5	18.0	20.0	22.4	26.8	
Capacity Range	Cool (kW)	5.0-11.2	5.7-14.0	6.2-15.5	7.3-16.3	10.8-20.0	12.0-22.4	15.0-24.0	
	Heat (kW)	5.1-12.8	6.0-16.2	6.2-18.0	7.3-18.2	12.0-22.4	13.4-25.0	16.8-26.8	
Power Input (Rated)	Cool (kW)	2.69	3.68	4.13	4.92	5.61	6.08	7.47	
	Heat (kW)	3.02	3.79	4.29	4.72	5.81	6.17	8.14	
E.E.R./C.O.P	Cool/Heat	3.72/4.14	3.40/3.96	3.39/3.85	3.25/3.81	3.21/3.44	3.29/3.63	3.21/3.29	
Airflow Rate (Rated)	l/s	800	840	1000	1120	1160	1200	1400	
Indoor Sound Level (H) @ 1.5m	dBA	44	45.5	46	48	45	44	46	
Piping Length	(m)	75				150		150	
Indoor Fan Speeds		H/M/L							
Dimensions (HxWxD)	Indoor (mm)	360x1157x899	360x1400x899	430x1400x943		470x1133x919	470x1333x919	470x1333x919	
	Outdoor (mm)	1430x940x320				1657x930x765		1657x930x765	
Weight	Indoor (kg)	44	59	62	62	70	79	85	
	Outdoor (kg)	108	108	108	117	192		203	
Power Supply	V/Hz	3 Phase, 380-415V, 50Hz							
Compressor Type		Hermetically Sealed Scroll Type							
Refrigerant		R410A							
Pipe Sizes	Liquid (mm)	9.5 (Flared)				9.5 (Brazed)			
	Gas (mm)	15.9 (Flared)				19.1 (Brazed)		22.2 (Brazed)	
	Drain (mm)	ID 25 / OD 32				BSP 3/4 inch Internal Thread			
Supply Air Opening	mm (HxW, Flange)	245x852	245x1152	315x1152		350x918	350x1118		
Return Air Opening	mm (Oval)	2x400 (Oval)				393x918 (Flange)	393x1118 (Flange)		
Outdoor Operating Range	Cool (°CDB)	-5 to 46				-5 to 49			
	Heat (°CWB)	-15 to 16				-20 to 16			
EPA Sound Power Level	dBA	69	-	-	-	-	-	-	
Outdoor Sound Level (H) @ 1m	PressuredBA(C/H)	53/55	54/56		57/59	56/56		57/57	

Notes:

- The Rated Capacity, Power Input and Running Current are measured in accordance with AS/NZS 3823.1.2
Cooling: Indoor temp: 27°CDB/19°CWB, Outdoor temp: 35°CDB/24°CWB
Heating: Indoor temp: 20°CDB/15°CWB, Outdoor temp: 7°CDB/6°CWB
- Indoor and outdoor sound levels are determined in an anechoic chamber and may differ on the unit is installed due to ambient conditions

PRODUCT SPECIFICATION

Standard Inverter - Single + Three Phase



RZQ71L



RZQ100L



RZQ125L



RZQ140L
RZQ160L



RZQ180L
RZQ200L
RZQ250L

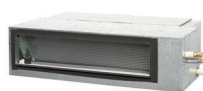

FDYQ71LB



FDYQ100LB



FDYQN125LA
FDYQN140LB
FDYQN160LA



FDYQ180LB
FDYQ200LB
FDYQ250LB

		SINGLE PHASE					THREE PHASE		
INDOOR UNIT		FDYQN71LBV1	FDYQN100LBV1	FDYQN125LAV1	FDYQN140LBV1	FDYQN160LBV1	FDYQN180LBV1	FDYQN200LBV1	FDYQN250LBV1
OUTDOOR UNIT		RZQ71LV1	RZQ100LV1	RZQ125LV1	RZQ140LV1	RZQ160LV1	RZQ180LY1	RZQ200LY1	RZQ250LY1
Rated Capacity	Cool (kW)	7.1	10.0	12.5	14.0	15.5	18.0	20.0	23.5
	Heat (kW)	7.5	12.5	15.0	16.5	18.0	20.0	22.4	26.8
Capacity Range	Cool (kW)	3.2-7.1	5.0-10.0	5.7-12.5	6.2-14.0	7.3-15.5	10.8-18.0	12.0-20.0	15.0-23.5
	Heat (kW)	3.5-7.5	5.1-12.5	6.0-15.0	6.2-16.5	7.3-18.0	12.0-20.0	13.4-22.4	16.8-26.8
Power Input (Rated)	Cool (kW)	2.25	3.12	4.14	4.65	4.97	5.88	6.44	7.85
	Heat (kW)	2.29	3.59	4.48	4.48	4.83	6.15	7.00	8.47
E.E.R./C.O.P	Cool/Heat	3.15/3.27	3.21/3.48	3.02/3.35	3.01/3.68	3.12/3.73	3.06/3.25	3.11/3.20	2.99/3.16
Airflow Rate (Rated)	l/s	566	800	840	1000	1120	1180	1200	1400
Indoor Sound Level (H) @ 1.5m	dBA	41	44	45	48.5	50.5	45.5	44	49.5
Piping Length	(m)	50	75				50		
Indoor Fan Speeds		H/M/L							
Dimensions (HxWxD)	Indoor (mm)	300x1090x863	360x1157x899	360x1498x899			500x1230x970	500x1430x970	
	Outdoor (mm)	770x900x320	990x940x320	1170x900x320	1430x940x320		1680x930x765		
Weight	Indoor (kg)	40	44	61	61	61	78	86	92
	Outdoor (kg)	64	75	98	108	117	192	192	193
Power Supply	V/Hz	1 Phase, 220-240V, 50Hz					3 Phase, 415v, 50Hz		
Compressor Type		Hermetically Sealed Swing Type	Hermetically Sealed Scroll Type						
Refrigerant		R410A							
Pipe Sizes	Liquid (mm)	9.5 (Flared)					9.5 (Brazed)		
	Gas (mm)	15.9 (Flared)					19.1 (Brazed)	22.2 (Brazed)	
	Drain (mm)	ID 25 / OD 32					BSP 3/4 inch Internal Thread		
Supply Air Opening	mm (HxW, Flange)	185x852	245x852	243x1152			376x827	376x938	
Return Air Opening	mm (Oval)	1x400 (Oval)	2x400 (Oval)				350x918 (Flange)	350x1118 (Flange)	
Outdoor Operating Range	Cool (°CDB)	-5 to 46					-5 to 43		
	Heat (°CWB)	-15 to 16					-20 to 16		
EPA Sound Power Level	dBA	66	69	-	-	-	-	-	-
Outdoor Sound Level (H) @ 1m	Pressure dBA (C/H)	49/51	51/53		54/56	57/59	57/57		57/58

Notes:

- i. The Rated Capacity, Power Input and Running Current are measured in accordance with AS/NZS 3823.1.2
Cooling: Indoor temp: 27°CDB/19°CWB, Outdoor temp: 35°CDB/24°CWB
Heating: Indoor temp: 20°CDB/15°CWB, Outdoor temp: 7°CDB/6°CWB
- ii. Indoor and outdoor sound levels are determined in an anechoic chamber and may differ on the unit installed due to ambient conditions

PRODUCT SPECIFICATION

Slimline - Single + Three Phase



RZQS50A
RZQS60A



RZQS71A



RZQS100A



FBQ50E
FBQ60E
FBQ71E
FBQ100E

		SINGLE PHASE				THREE PHASE
INDOOR UNIT		FBQ50EVE	FBQ60EVE	FBQ71EVE	FBQ100EVE	FBQ100EVE
OUTDOOR UNIT		RZQS50AV1	RZQS60AV1	RZQS71AV1	RZQS100AV1	RZQS100AY1
Rated Capacity	Cool (kW)	5.0	5.8	7.1	10.0	10.0
	Heat (kW)	6.0	7.0	8.0	11.2	11.2
Capacity Range	Cool (kW)	3.2-5.6	3.2-6.0	3.2-8.0	5.0-11.2	5.0-11.2
	Heat (kW)	3.5-7.0	3.5-8.0	3.5-9.0	5.1-12.8	5.1-12.8
Power Input (Rated)	Cool (kW)	1.35	1.59	1.99	2.73	2.73
	Heat (kW)	1.43	1.83	1.98	2.82	2.82
E.E.R./C.O.P	Cool/Heat	3.70/4.20	3.65/3.83	3.57/4.04	3.66/3.97	3.66/3.97
Airflow Rate (Rated)	l/s	300	300	383	533	533
Indoor Sound Level (H) @ 1.5m	dB(A)	35	35	38	38	38
Piping Length	(m)	50				75
Indoor Fan Speeds		H/M/L				
Dimensions (HxWxD)	Indoor (mm)	245x1000x800				245x1400x800
	Outdoor (mm)	770x900x320		990x940x320		1430x940x320
Weight	Indoor (kg)	37	37	37	47	47
	Outdoor (kg)	64	64	75	108	108
Power Supply	V/Hz	1 Phase, 220-240V, 50Hz				3 Phase, 380-415V, 50Hz
Compressor Type		Hermetically Sealed Swing Type			Hermetically Sealed Scroll Type	
Refrigerant		R410A				
Pipe Sizes	Liquid (mm)	9.5 (Flared)				
	Gas (mm)	15.9 (Flared)				
	Drain (mm)	ID 25 / OD 32				
Supply Air Opening	mm (HxW, Flange)	176x792			176x1192	
Return Air Opening	mm (Oval)	208x952			208x1352	
Outdoor Operating Range	Cool (°CDB)	-5 to 46				
	Heat (°CWB)	-15 to 16				
EPA Sound Power Level	dB(A)	66	66	69	69	69
Outdoor Sound Level (H) @ 1m	Pressure dB(A) (C/H)	48/50		50/52	53/55	53/55

Notes:

- i. The Rated Capacity, Power Input and Running Current are measured in accordance with AS/NZS 3823.1.2
Cooling: Indoor temp: 27°CDB/19°CWB, Outdoor temp: 35°CDB/24°CWB
Heating: Indoor temp: 20°CDB/15°CWB, Outdoor temp: 7°CDB/6°CWB
- ii. Indoor and outdoor sound levels are determined in an anechoic chamber and may differ once the unit is installed due to ambient conditions

PRODUCT SPECIFICATION

Bulkhead - Single Phase



RXS25LB
RXS35LB



RXS50LB



RXS60LB



FDXS25L
FDXS35L
FDXS50L
FDXS60L

INDOOR UNIT		FDXS25LVMA	FDXS35LVMA	FDXS50LVMA	FDXS60LVMA
OUTDOOR UNIT		RXS25LBVMA	RXS35LBVMA	RXS50LBVMA	RXS60LBVMA
Rated Capacity	Cool (kW)	2.4	3.4	5.0	6.0
	Heat (kW)	3.2	4.0	5.8	7.0
Capacity Range	Cool (kW)	1.3-3.0	1.4-3.8	2.3-5.3	3.0-6.5
	Heat (kW)	1.3-4.5	1.4-5.0	2.3-6.0	3.0-8.0
Power Input (Rated)	Cool (kW)	0.69	1.03	1.5	1.91
	Heat (kW)	0.91	1.14	1.72	2.17
E.E.R./C.O.P	Cool/Heat	3.48/3.52	3.30/3.51	3.33/3.37	3.14/3.23
Airflow Rate (Rated)	l/s	158	200	267	267
Indoor Sound Level (H) @ 1.5m	dBA	35	37	38	38
Piping Length	(m)	20		30	
Indoor Fan Speeds		5 Steps, Quiet and Automatic			
Dimensions (HxWxD)	Indoor (mm)	200x900x620		200x1100x620	
	Outdoor (mm)	550x765x285		770x900x320	990x940x320
Weight	Indoor (kg)	25	27	30	30
	Outdoor (kg)	34	34	71	80
Power Supply	V/Hz	1 Phase 220-240V, 50Hz			
Compressor Type		Hermetically Sealed Swing Type			
Refrigerant		R410A			
Pipe Sizes	Liquid (mm)	6.4 (Flared)		9.5 (Flared)	
	Gas (mm)	9.5 (Flared)		15.9 (Flared)	
	Drain (mm)	ID 20 / OD 26			
Supply Air Opening	mm (HxW, Flange)	153x860		153x1060	
Return Air Opening	mm (Oval)	160x780		160x980	
Outdoor Operating Range	Cool (°CDB)	10 to 46			
	Heat (°CWB)	-15 to 18			
EPA Sound Power Level	dBA	62	63	65	68
Outdoor Sound Level (H) @ 1m	Pressure dBA (C/H)	47/48	49/49	50/51	52/54

Notes:

- i. The Rated Capacity, Power Input and Running Current are measured in accordance with AS/NZS 3823.1.2
Cooling: Indoor temp: 27°CDB/19°CWB, Outdoor temp: 35°CDB/24°CWB
Heating: Indoor temp: 20°CDB/15°CWB, Outdoor temp: 7°CDB/6°CWB
- ii. Indoor and outdoor sound levels are determined in an anechoic chamber and may differ on the unit installed due to ambient conditions

FEATURES AND BENEFITS

ENERGY EFFICIENCY



INVERTER OPERATION

An inverter system works like the accelerator of a car, gently increasing or decreasing power to steadily maintain your optimum temperature without fluctuations. That means uninterrupted comfort and significant savings on running costs. Daikin premium inverters can also reach your desired temperature faster than conventional heat pumps.



AUTOMATIC MODE CHANGEOVER

Automatically selects heating or cooling modes to suit thermostat settings and prevailing room temperature.



PREDICTED MEAN VOTE (PMV) CONTROL

Measures indoor and outdoor temperatures to calculate the ideal room temperature, gently adjusting it for the optimum balance between efficiency and comfort.



TEMPERATURE LIMIT OPERATIONS

Lets you pre-define temperature range for cooling or heating, to reduce energy consumption.



HOME LEAVE

Ideal for cold climates, when activated, home leave turns your heat pump on automatically when room temperatures drop below 10°C, keeping your home at or above 10°C so it never gets really cold.

AUTOMATIC FUNCTIONS



AUTO RESTART AFTER POWER FAILURE

The heat pump memorises the settings for mode, airflow, temperature etc. and automatically returns to them when power is restored after a power failure.



SELF DIAGNOSTICS WITH DIGITAL DISPLAY

Malfunction codes are displayed on your control panel for fast, easy fault diagnosis and maintenance.



ANTI-CORROSION COATING

An anti-corrosion coating on outdoor heat exchangers gives greater resistance to salt damage and atmospheric corrosion.



COMPACT DESIGN

The compact design of Daikin ducted indoor units allows them to be installed in confined areas, and they can also be dismantled for easier installation in tight roof spaces.

COMFORT CONTROL



NIGHT QUIET MODE

Outdoor unit noise is automatically reduced by 3 dB when outdoor temperatures fall more than 6°C from the day's maximum (set during installation).



PROGRAM DRY MODE

In this mode, priority is given to reducing the level of humidity in the room rather than room temperature.



INTELLIGENT DEFROST

During heating operation in low ambient temperature conditions, frost can form on the outdoor unit heat exchanger which can reduce your heat pump's performance. Daikin's intelligent defrost system constantly monitors a range of system parameters and temperatures to determine the optimum time to commence a defrost operation for maximum performance in cold conditions.



HOT START

Prior to heating, the indoor unit warms to a pre-set temperature before the fan switches on, ensuring only warm air is discharged and eliminating cold drafts.



QUICK COOL/HEAT – POWERFUL MODE

This feature temporarily increases power to more rapidly reach your desired room temperature, before automatically returning to normal operation.

TIMER CONTROL



24 HOUR ON/OFF TIMER

This timer can be pre-set to start and stop at any time within a 24 hour period.



NIGHT SET MODE

A timer off circuit gradually adjusts pre-set cooling and heating levels, preventing sudden temperature changes during the night and improving economy.



SEVEN DAY TIME CLOCK

This allows you to program your heat pump to turn on or off at set times for every day of the week.

FEATURES CHECKLIST

	PREMIUM INVERTER (1 PHASE)	PREMIUM INVERTER (3 PHASE)	PREMIUM INVERTER SLIM-LINE (1 PHASE)	INVERTER BULKHEAD (1 PHASE)	STANDARD INVERTER (1 PHASE)	STANDARD INVERTER (3 PHASE)
	FDYQ50DV1 FDYQ60DV1 FDYQ71LBV1 FDYQ100LBV1 FDYQ125LBV1 FDYQ140LCV1 FDYQ160LBV1	FDYQ100LBV1 FDYQ125LBV1 FDYQ140LCV1 FDYQ160LBV1 FDYQ180LCV1 FDYQ200LCV1 FDYQ250LCV1	FBQ50EVE FBQ60EVE FBQ71EVE FBQ100EVE (3 phase) FBQ100EVE	FDXS25LVMA FDXS35LVMA FDXS50LVMA FDXS60LVMA	FDYQN71LBV1 FDYQN100LBV1 FDYQN125LAV1 FDYQN140LBV1 FDYQN160LAV1	FDYQN180LBV1 FDYQN200LBV1 FDYQN250LBV1
Inverter Operation	✓	✓	✓	✓	✓	✓
DC Indoor Fan Motor	✓	✓	✓	✓	✓	✓
Swing Compressor	✓ ¹		✓ ¹	✓	✓ ¹	
Scroll Compressor	✓	✓	✓		✓	✓
High Efficiency (HI-X) Indoor Heat Exchanger Coil	✓	✓	✓	✓	✓	✓
Automatic Mode Changeover	✓	✓	✓	✓	✓	✓
P.M.V. Control	✓	✓	✓		✓	✓
Temperature Limit Operations ⁴	✓	✓	✓		✓	✓
Home Leave ⁴	✓	✓	✓		✓	✓
Auto Restart After Power Failure	✓	✓	✓	✓	✓	✓
Self Diagnostics	✓	✓	✓	✓	✓	✓
Anti-Corrosion Coating for Outdoor Heat Exchanger	✓	✓	✓	✓	✓	✓
Indoor Unit Designed and Built in Australia	✓	✓			✓	✓
Long Piping Length	✓	✓	✓		✓	✓
High Strength Galvanized Steel Casing	✓	✓	✓	✓	✓	✓
Night Quiet Mode ⁸	✓ ³	✓	✓		✓	✓
Low Noise Operation ⁹	✓	✓	✓		✓	✓
Program Dry Mode	✓	✓	✓	✓	✓	✓
Intelligent Defrost	✓	✓	✓	✓	✓	✓
Hot Start	✓	✓	✓	✓	✓	✓
Quick Cool / Heat – Powerful Mode	✓	✓	✓	✓	✓	✓
Automatic Fan Speed				✓		
Automatic Airflow Adjustment	✓ ⁵	✓ ⁵	✓		✓ ⁵	
Indoor Fan Cycles with Compressor ²	✓	✓	✓		✓	✓
24 Hour On/Off Timer	✓	✓	✓	✓	✓	✓
Night Set Mode ⁸				✓		
Seven Day Time Clock	✓	✓	✓		✓	✓
Electronic Control System	✓	✓	✓	✓	✓	✓
Airside Control	✓ ⁶	✓ ⁶				
Wireless LAN Connection	✓ ⁷	✓ ⁷	✓ ⁷		✓ ⁷	✓ ⁷

1. FDYQ50-60DV1, FDYQ71LBV1, FDYQN71LBV1 and FBQ50-71EVE only – all others are scroll-type
2. Can be set up by installer during installation
3. Not available for FDYQ50-60DV1
4. Not available on Zone Controller
5. Available on FDYQ50-60DV1, FDYQ71-100LBV1, FDYQN71-100LBV1 & FDYQ180-250LCV1 only

6. Only available on Zone Controller
7. Optional accessory & only compatible with Nav Ease or Zone Controller
8. Night Quiet and Night Set modes may reduce capacity
9. Low noise operation requires optional P.C.B.



The specifications, designs and information in this brochure are subject to change without notice. Unit colours shown are as close as possible to actual unit colours. Colours depicted in this brochure may vary slightly.

ASSUMPTIONS

All representations made in Daikin marketing and promotional material are based on the assumptions that the correct equipment has been selected, appropriately sized and installed in accordance with Daikin's installation instructions and standard industry practices.

QUALITY CERTIFICATIONS

Daikin Industries Limited was the first air conditioning equipment manufacturer in Japan to receive ISO 9001 certification. All Daikin manufacturing facilities have been certified to ISO 9001 Quality Management System requirements. ISO 9001 is a certificate for quality assurance concerning 'design, development, manufacturing, installation and related service' of products manufactured at that factory.

ENVIRONMENTAL CERTIFICATIONS

Daikin Industries Limited has received ISO 14001 Environmental Certification for the Daikin production facilities listed below. ISO 14001 is an international standard specifying requirement for an environmental management system, enabling an organisation to formulate policy and objectives, taking into account legislative requirements and information about significant environmental impacts. It applies to those environmental aspects within the organisation's control and over which it can be expected to have an influence.

The certification relates only to the environmental management system and does not constitute any endorsement of the products shipped from the facility by the International Organisation for Standardisation.

Head Office / Tokyo Office
Shiga Plant (Japan)
Sakai Plant (Japan)
Daikin Industries Ltd (Thailand)
Yodogawa Plant (Japan)
Daikin Australia Pty, Ltd.

Certificate number: EC02J0355
Certificate number: EC99J2044
Certificate number: JQA-E-80009
Certificate number: JQA-E-90108
Certificate number: EC99J2057
Certificate number: CEM20437

Daikin Air Conditioning
New Zealand Limited
(ISO 9001)
QMS42380
Auckland



Residential Air Conditioning
Manufacturing Div (ISO 9001)
JQA-0486 May 2, 1994
(Shiga Plant)

Commercial Air Conditioning
and Refrigeration
Manufacturing Div (ISO 9001)
JMI0107 December 28, 1992
(Kanaoka Factory and Rinkai
Factory at Sakai Plant)

Industrial System and Chiller
Products Manufacturing Div
(ISO 9001)
JQA-0495 May 16, 1994
(Yodogawa Plant and Kanaoka
Factory and Kishiwada Factory)

Daikin Europe N.V (ISO 9001)
Lloyd 928589.1 June 2, 1993

Daikin Industries (Thailand) Ltd
JQA-1452 September 13, 2002
(ISO 9001)



DEALER

For all sales enquiries email:
[sales @daikin.co.nz](mailto:sales@daikin.co.nz)

For customer service or technical support:
0800 209 010

daikin.co.nz